

# ValveExpert Checker

Manual

Version 2.3

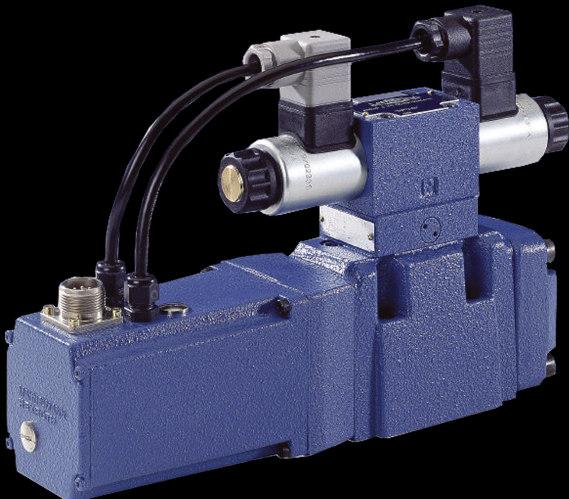
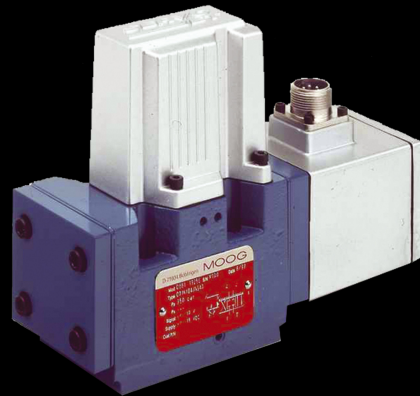
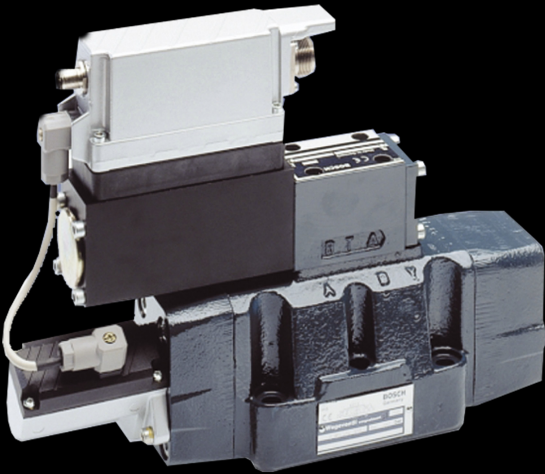
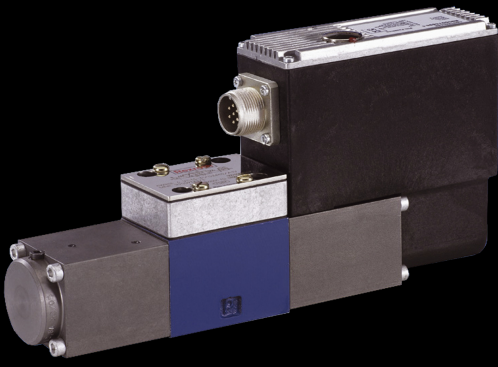

# ValveExpert Checker

Portable Service Set with Universal  
Test Device for Servo- and Proportional  
Valves with Integrated Electronics



CE

Version 2.3

# Contents

<b>Device Overview</b>	<b>2</b>
<b>Main Features</b>	<b>3</b>
<b>Technical Data</b>	<b>4</b>
<b>Functional Description and Operating Instructions</b>	<b>5</b>
<b>Power Supply / Connectors / Cables</b>	<b>10</b>

## Device Overview

The test device ValveExpert Checker 2.3 (see Figure 1) is suitable for the control and functional testing of proportional valves with integrated electronics and an operating voltage of  $\pm 15\text{V}$  or  $+24\text{V}$ . It supports the following operating modes:

- **External operation.** In this case the electric power and command signal are supplied from the control cabinet to the valve. ValveExpert Checker 2.3 allows to test the operating voltage, the command values from the control cabinet, and actual feedback values from the valve.
- **Internal/External operation.** In this case control signal is supplied by the test device. Electric power is supplied from the control cabinet. ValveExpert Checker 2.3 allows to test the operating voltage from the control cabinet, check the real command values from the test device and actual feedback values from the valve.
- **Internal operation.** In this case command value is supplied by the test device. Electric power is supplied via a separate power supply unit. ValveExpert Checker 2.3 allows to test the operating voltage of the power supply, check the real control signal from the test device, and actual feedback values from the valve.



Figure 1: Test device ValveExpert Checker 2.3.



The test device may only be used by persons who are familiar with the device, the valve, and the hydraulic system. When set accordingly, the unit ignores control signals that come from the system. If control-side safety regulations are provided, they are thereby rendered inoperable. No liability will be accepted for damage caused by incorrect operation!

## Main Features

- The test device ValveExpert Checker 2.3 is used to control and carry out functional tests on servo and proportional valves with integral electronics and operating voltages of  $\pm 15V$  or  $+24V$
- Simplifies commissioning and troubleshooting in hydraulic systems with servo and proportional valves
- All standard servo- and proportional valves with 6+PE connectors are supported (MOOG, Parker-Hannifin, Bosch-Rexroth, Eaton, and many others)
- Additional control for ON/OFF pilot valve
- Intuitively simple and comfortable interface
- Extremely bright OLED display and LED indicators for comfortable operating at any light conditions
- Supports external and internal control modes
- Advanced set of control modes:  $-10V \dots +10V$ ,  $-2V \dots +2V$ ,  $0V \dots +10V$ ,  $-10mA \dots +10mA$ ,  $-2mA \dots +2mA$ ,  $0mA \dots +10mA$ ,  $4mA \dots 20mA$ ,  $10mA \dots 14mA$ ,  $-20mA \dots +20mA$
- The device keeps the last settings after switching power off
- Supports current and voltage feedback signals
- Allows to monitor voltage of the power supply and enable signals
- Enable output includes the current limiter for safe operation
- Fast access to any item of the control menu
- The service case comprises a test device as well as an optional power supply unit ( $+24V$ ,  $3.75A$ ) and connecting cables
- Reverse polarity, overload, and short circuit protections
- Compact and robust construction
- Completely sealed enclosure
- High reliable keyboard
- Robust waterproof case

## Technical Data

Ingress protection rating:	IP64 (test device)
Servo valve connector:	6+PE pole, EN 175201 Part 804
Pilot valve connector:	DIN EN 175301-803, form A
Operating voltage:	18...36VDC (full functionality) 4.5...36VDC (measurement functions)
No load power consumption:	3.4W (Max)
Max. load capacity (Pin-A and Pin-B):	3A
Control signal modes (Pin-D and Pin-E):	-10V...+10V, -2V...+2V, 0V...+10V, -10mA...+10mA, -2mA...+2mA, 0mA...+10mA, +4mA...+20mA, +10mA...+14mA, -20mA...+20mA
Current limiter for voltage control modes:	20mA...30mA
Current sensing resistors:	9.53 $\Omega$
Precision of the measurements:	Max error is the last digit of the display value
Enable input (Pin-C):	Disable: 0V...4V Enable: 8V...30V
Enable output (Pin-C):	Disable: 0V Enable: (A-B)V - 0.8V (with current limiter +10mA)
Feedback signal (Pin-F):	-30V...+30V -30mA...+30mA
Pilot valve voltage:	(A-B)V
Max. load for pilot valve:	1.6A (overload protected)
Microcontroller:	32bit, 84MHz, AT91SAM3X8E
ADC converters:	8-channels, 12bit, 200kHz
Display:	3.2" OLED, Yellow, 256x64 Matrix
Dimensions:	490mm x 360mm x 120mm (case) 185mm x 110mm x 70mm (unit)
Weight:	4.500kg (complete with case) 0.740kg (unit only)
CE tests:	EN 50 081-1 EN 50 082-2 EN 60 742
Customs tariff number:	90318038
Power supply:	Input: 90...264VAC Output: 24V, 3.75A (90W) See specs Mean Well GS90A24-P1M for details
Case:	Robust waterproof See specs Pelican 1490 for details

## Functional Description and Operating Instructions

Control elements, LED indicators, OLED display, and connectors of ValveExpert Checker 2.3 are shown on the Figure 2. Table 1 gives a short description for the all items. Figure 3 and Table 2 below describe elements of the OLED display.

### Connections

Plug connector (J) (see Figure 2) is used to connect the cable coming from the control cabinet. The signals coming from the machine can be measured by ValveExpert Checker 2.3. In case if no power from the machine available, a corresponding power supply unit can be connected to the connector (J). Output socket (I) is used to connect the device with a proportional valve. The signals going to or coming from the valve can be measured by the device. Output socket (K) is used to connect the device with a pilot valve.

### Voltage Supply

The test device can be supplied with +24V or  $\pm 15V$ , depending on the operating voltage required for the valve. This voltage goes to the 6+PE plug connector (J) (see Figure 2) from the control cabinet or external power supply. The settings (6) (see Figure 3) must be set in according to the chosen power supply.

### LED Indicators

There are five LED indicators on the front panel of the device. The LEDs (D), (E) and (F) indicate the states of the corresponded buttons (N), (M) and (L). The LEDs (B) and (G) show if Enable Input (Enable signal from the control cabinet) or Enable Output (Enable signal to the valve) is switched on.

### OLED Display

OLED display (C) (see Figure 2) shows values of control signal (1) and actual values of the feedback signal (2) (see Figure 3)). Moreover, the multimeter (2) allows to test voltage of the power supply and actual value of Enable signal. If necessary, it can be switched off. The items (3), (4), (5), and (6) show settings of the device. Possible values of the settings are shown of the Figure 5.

### Changing the Settings

The push-buttons (see Figure 2 and Table 1) are used to set up the device. The button "OK" (see (P) on Figure 2) is used to activate the menu navigator and save the settings. The buttons with arrows are used to navigate and change menu values. Flow diagram, shown on the Figure 5, demonstrates the all possible settings. Button "Internal" (see (N) on Figure 2) activates/deactivates manual mode of the device. The manual mode allows to control valves with the knob (O). The button (M) activates/deactivates the Enable signal. If "Internal" mode is not

active, the button (M) allows to interrupt or pass on the Enable signal from control cabinet. The button (L) controls output for a "Pilot" valve. In case if overload protection was activated, the button (L) allows to reset the "Alarm" state. The button (L) can be used to display serial number and current version of the ValveExpert Checker (see Figure 4). To activate this mode, hold the button down while switching the device on.

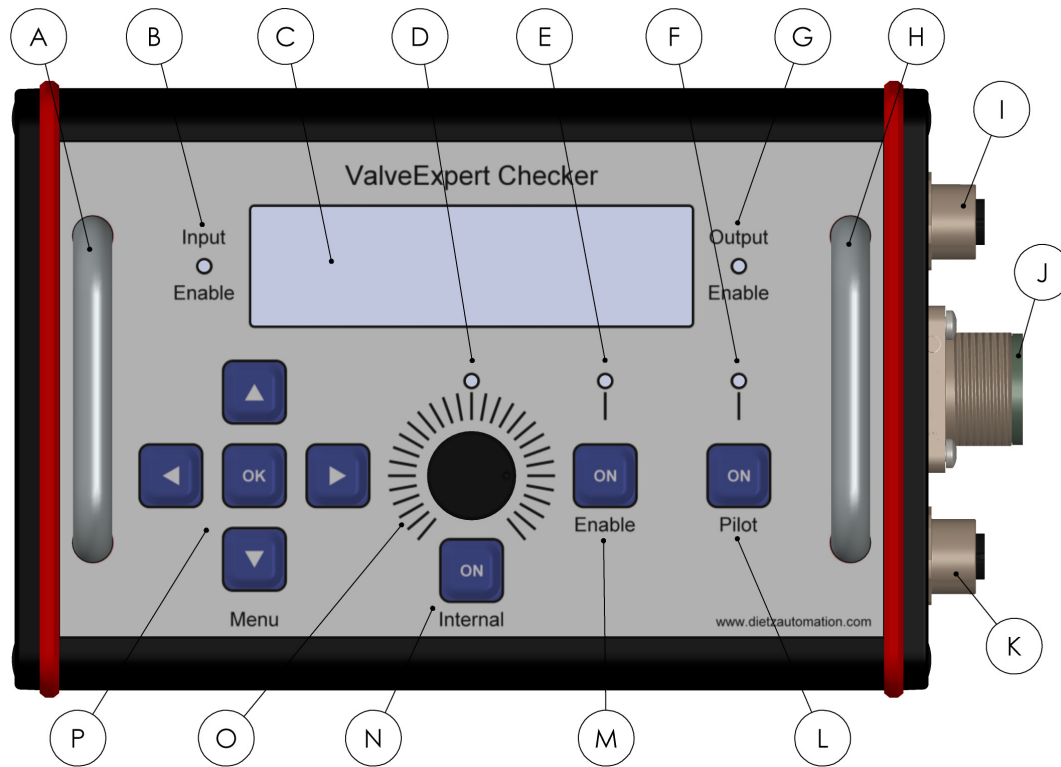



Figure 2: Front panel of the test device ValveExpert Checker 2.3 (see Table 1 for description).

- Valves with integrated electronics and an operating voltage of +24V without Enable input can use Pin-C as reference potential for the valve actual value. In this case, "Pin-C" the settings (5) (see Figure 3) must be set to "Ref".
- Valves with integrated electronics and an operating voltage of +24V with Enable input use Pin-B as reference potential for the valve actual value. In this case, the "Pin-C" settings (5) (see Figure 3) must be set to "En.". 
- Valves with integrated electronics and an operating voltage of  $\pm 15V$  utilize Pin-C for power ground. Device will automatically set the parameter "Pin-C" (5) (see Figure 3) to "0V".



Item	Label	Functional element
(A) (H)		Steel handles to protect the device and comfortable use
(B)	Input Enable	Red LED to indicate the Enable state of the input signal
(C)		OLED display shows the values of the measured signals (actual value of control, valve feedback signal, power supply voltage, voltage of Enable signal) and current settings of the device (range of the control, type of the feedback, settings of the Pin-C, specified power supply) )
(D)		Blue LED to indicate the "Active" state of the manual control mode
(E)		Blue LED to indicate the state of the Enable button
(F)		Blue LED to indicate the state of the Pilot valve output button.
(G)	Output Enable	Red LED to indicate the Enable state of the output signal
(I)	Valve	Output socket: Connection on the proportional valve side (M12, Female, 8-Pole, IEC 61076-2-101)
(J)	Machine/Power	Input plug: Connection on the control side, or external power supply (Male, 6+PE, CA02COME14SA7P)
(K)		Output socket: Connection for the pilot valve (M12, Female, 5-Pole, IEC 61076-2-101)
(L)	Pilot	Push button to control Pilot valve
(M)	Enable	Push button to control Enable state
(N)	Internal	Push button to switch between internal and external control modes
(O)		Knob to control valve in manual mode
(P)	Menu	Set of push buttons to activate menu, make changes, and save the settings to the device

Table 1: Functional elements of the test device ValveExpert Checker 2.3 (see Figure 2).

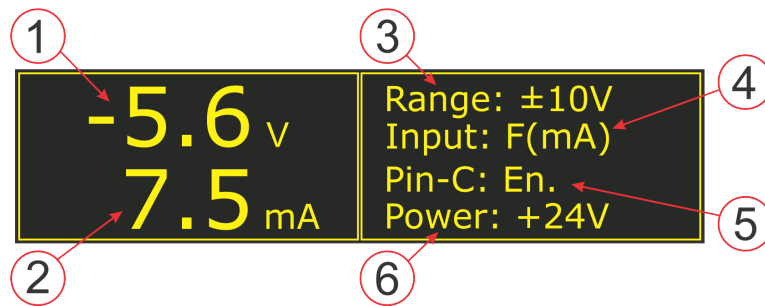

Figure 3: OLED display of ValveExpert Checker 2.3 (see Table 2 for description).

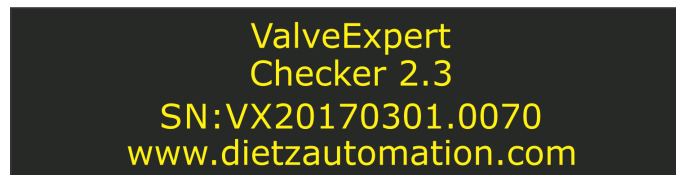

Figure 4: Display shows base information about the device. See details on the page 6 to activate this mode.





Item	Description
1	Actual value of the control signal. It shows value of manual control in case if manual control (defined by knob  ) is active, and value of external control coming from a machine and plugged into connector  if manual control is deactivated.
2	Actual value of the spool position, supply voltage, or value of the Enable signal. The current setting is shown on the OLED display (see  ). The option "Non" allows to make this value hidden.
3	Settings for the control signal  . See Figure 5 for possible values.
4	Settings for display value  . See Figure 5 for possible values.
5	Settings for Pin-C. See Figure 5 for possible values. The only option "Pin-C: 0V" (Pin-C is connected with 0V) is available in case of $\pm 15V$ power supply. Three options for +24V power supply are available: "Pin-C: En." (Pin-C is use for Enable signal), "Pin-C: N.C." (Pin-C is not connected), "Pin-C: Ref. (Actual value of the feedback signal is measured between Pin-F and Pin-C, i.e Pin-C is used as a reference for Pin-F.)
6	Settings for power supply. See Figure 5 for possible values. The setting "Power: +24V" is used for valves with rated supply voltage +24V. The setting "Power: $\pm 15V$ " is used for valves which are specified for dual power supply $\pm 15V$ .

Table 2: Elements of the OLED display (see Figure 3).

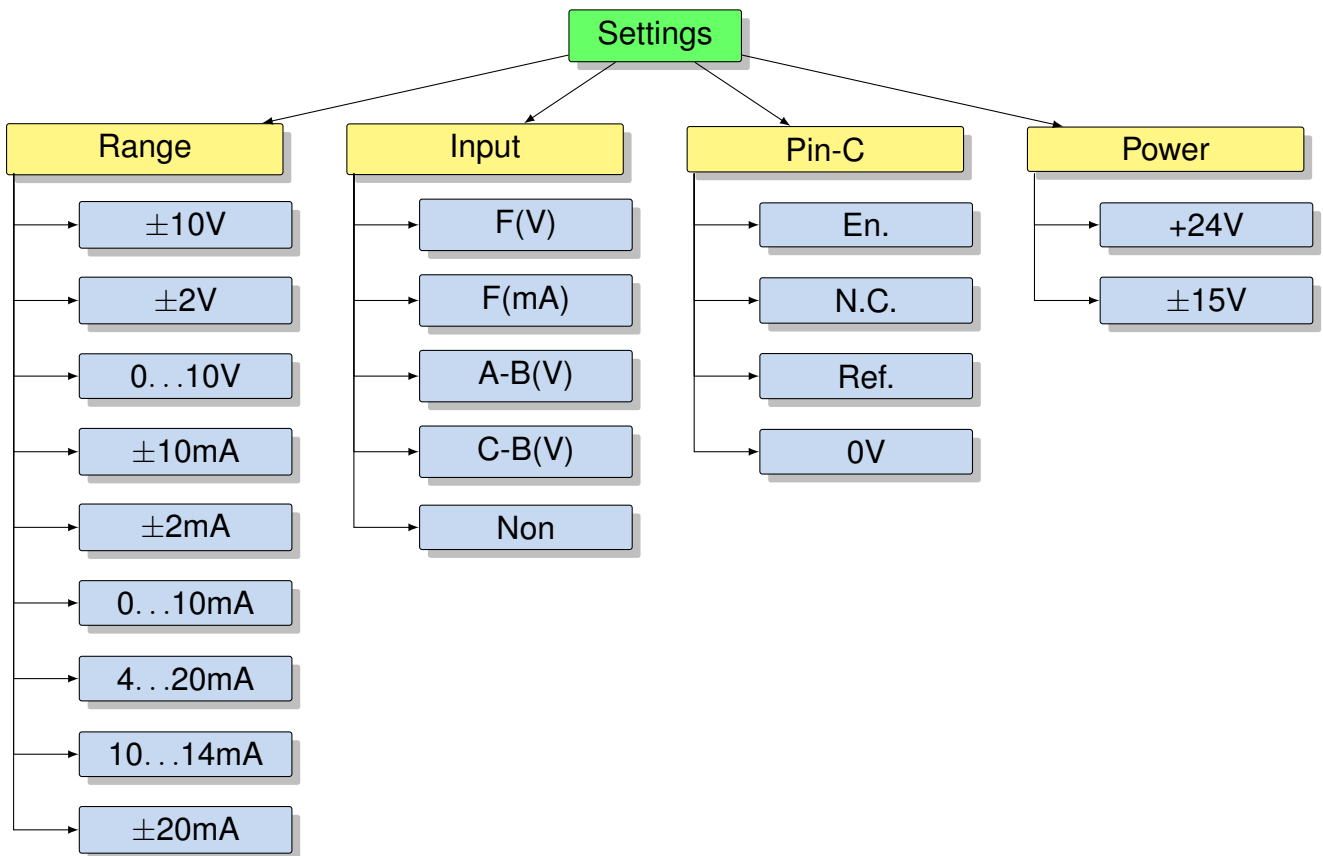

Figure 5: Flow diagram for settings of ValveExpert Checker 2.3 (see Figure 3 and Table 2).

**Range** This item allows to select mode of the control signal. There are nine control modes:  $-10V \dots +10V$ ,  $-2V \dots +2V$ ,  $0V \dots +10V$ ,  $-10mA \dots +10mA$ ,  $-2mA \dots +2mA$ ,  $0mA \dots +10mA$ ,  $4mA \dots 20mA$ ,  $10mA \dots 14mA$ ,  $-20mA \dots +20mA$ . In case of manual control, the selected mode defines minimum and maximum values of the control knob. In case of external control, the control knob is switched off, and the selected mode specifies type of the command values from the control cabinet.

**Input** The item "Input" specifies the signal to be measured by the the device. There are five different values. "F(V)" and "F(mA)" modes allows to measure actual values of the spool position. In case "F(V)" the spool position is defined by voltage on the pin F, and in case "F(mA)" the spool position is defined by current through the pin F. The mode "A-B(V)" allows to measure voltage between pins A and B, i.e. the supply voltage. The mode "C-B(V)" measures voltage between pins C and B, i.e. voltage of the enable signal or negative power supply for  $\pm 15V$  valves. The mode "Non" allows to hide the corresponded measurements.

**Pin-C** This item defines function of the pin C. In case "En." - the pin C is used for enable signal. In case "Ref." - the pin C is used as reference potential for the valve actual value. In case "0V" - the pin C is connected to 0V. In case "N.C." - the pin C is not used.

**Power** This item specifies type of the power supply. Two standard modes are supported:  $+24V$ , and  $\pm 15V$ .

## Power Supply / Connectors / Cables



Figure 6: Power supply unit (Input: 90...240VAC, Output: 24VDC, 3.73A, 90W). See Table 3 for Pin assignment. The Pin-A and Pin-B are used only.



Figure 7: ValveExpert Checker 2.3 can be supplied with different cables for the power unit. This Figure shows two cables which are mainly used in USA, Canada, Mexico, Japan, Europe & Russia.



Figure 8: Connector view of the test device ValveExpert Checker 2.3. See Tables 3 and 4 for Pin assignment.



Figure 9: Cable to connect the test device with a servo- or proportional valve. See Table 3 for Pin assignment.



Figure 10: To support different types of servo- and proportional valves, customized cables can be supplied. The Figure shows a cable for proportional valves with 11+PE connector (not included by default).



Figure 11: Cable to connect the test device with a pilot valve (24VDC, 1.6A max). See Table 4 for Pin assignment.

<b>6+PE</b>	<b>M12-8</b>	<b>Valve version with operating voltage +24V</b>	<b>Valve version with operating voltage <math>\pm 15V</math></b>
A	1, 3	Supply +24V	Supply +15V
B	2, 4	Supply ground 0V	Supply -15V
C	5	Enable or Reference potential for actual value e.g. with 4WRSE (Rexroth)	Supply ground 0V
D	6	Positive command value	Positive command value
E	7	Negative command value	Negative command value
F	8	Actual value	Actual value
PE	Screen	Protective earth	Protective earth

Table 3: Pin assignment of the servo- or proportional valve cable (6+PE pole, EN 175201 Part 804 / M12, Male, 8-Pole, IEC 61076-2-101) and the corresponded device connector (M12, Female, 8-Pole, IEC 61076-2-101).

<b>DIN</b>	<b>M12-5</b>	<b>Valve version with operating voltage +24V</b>	<b>Valve version with operating voltage <math>\pm 15V</math></b>
1	4	Supply +24V	Supply +15V
2	3	Supply ground 0V	Supply -15V
PE	5	Protective earth	Protective earth

Table 4: Pin assignment of the pilot valve cable (DIN EN 175301-803, form A / M12, Male, 5-Pole, IEC 61076-2-101) and the corresponded device connector (M12, Female, 5-Pole, IEC 61076-2-101).

## Test Equipment for Servo- and Proportional Valves

© Dr. Mikhail Shashkov  
DIETZ automation GmbH  
Auf Maien 17  
66538 Neunkirchen  
Germany  
[www.dietzautomation.com](http://www.dietzautomation.com)  
March 2017

USt. ID Nr.: 219 401 070  
Geschäftsführer: Dr. Mikhail Shashkov  
Handelsregister: AG Saarbrücken HRB 12729

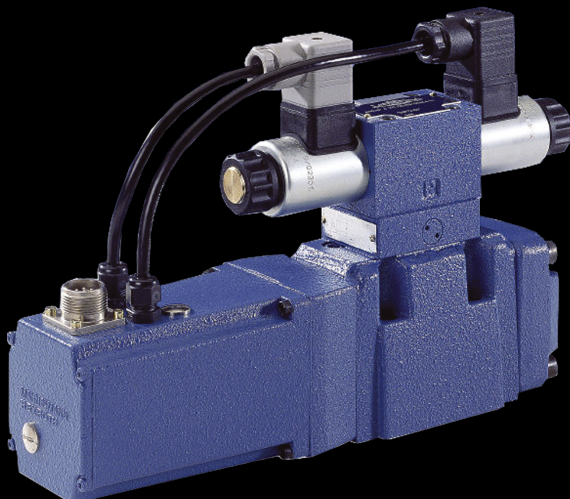
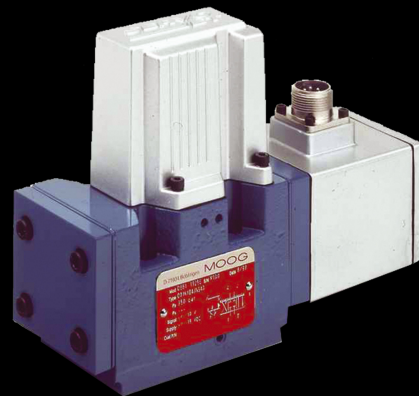
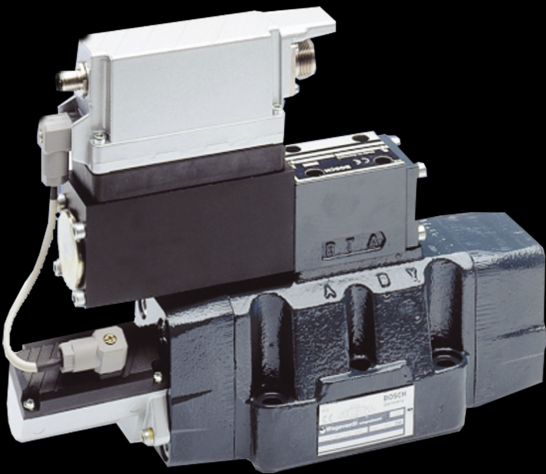
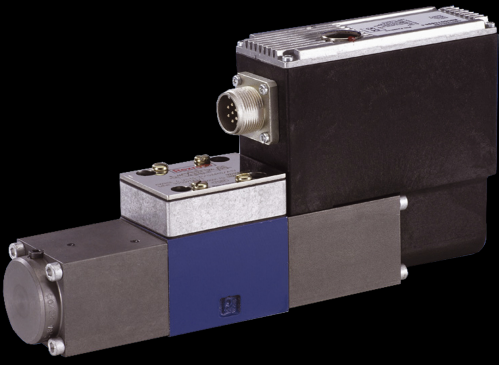

[www.dietzautomation.com](http://www.dietzautomation.com)